

# OUTLINE DIMENSIONAL DRAWING

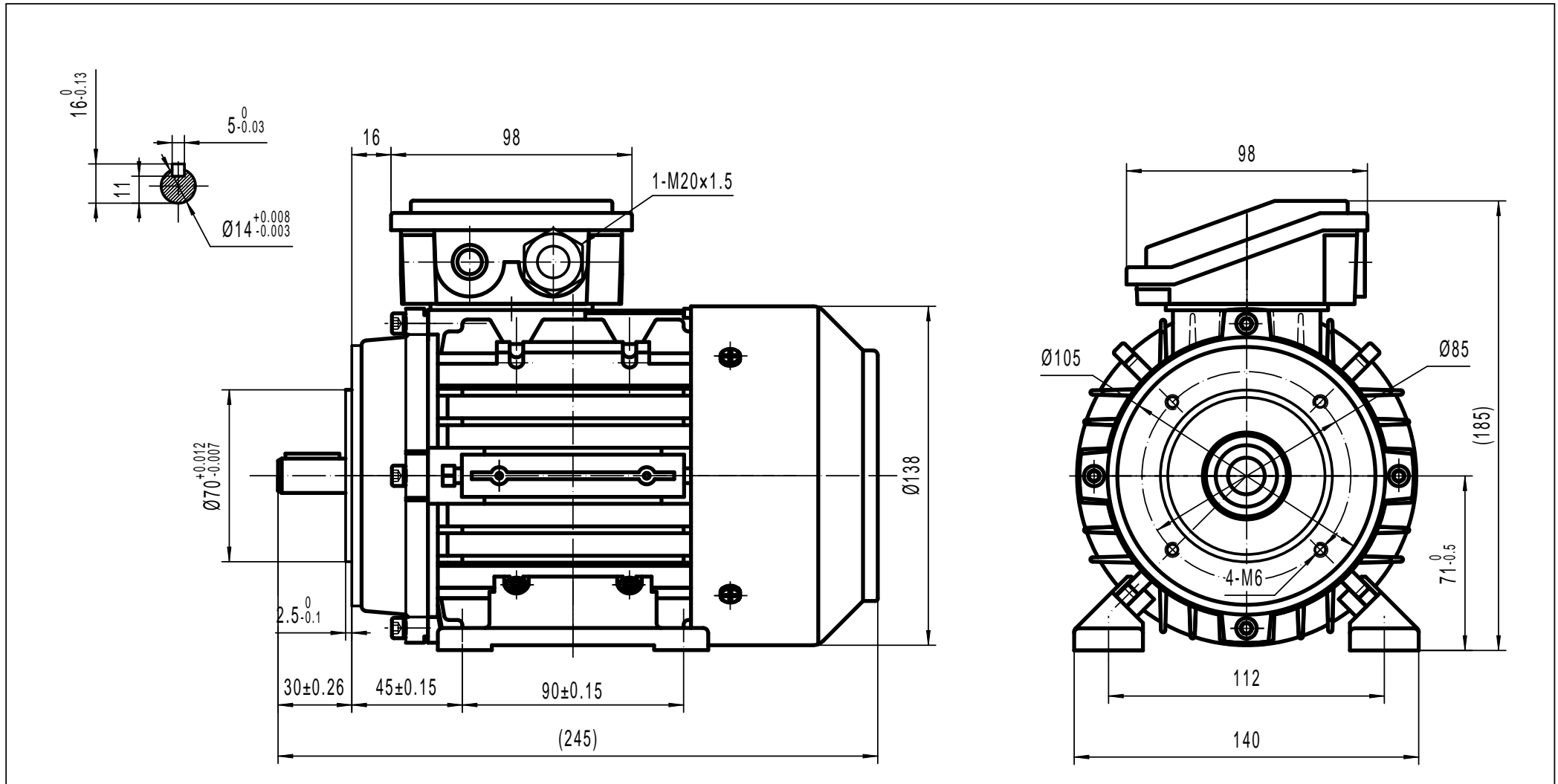

TECHTOP AUSTRALIA PTY LTD	
FRAME	TAI 71A B34
DATE	DRAWING NO.
2011/10/14	1ST082.052.001-010 A